

**Hawaiian
Electric**

The information found in this document are general guidelines that may be used to aid in the preparation of your service request proposal. Please be advised that depending on the specific needs and actual conditions of your project, Hawaiian Electric may require your design to comply with different specifications including specifications that include more stringent requirements than those included in these design specification guidelines. For further guidance and clarification on the actual specifications that will apply to your particular project, please refer to instructions issued by Hawaiian Electric's Planner or Engineer who is assigned to your particular (Project/Review Request/...). Additionally, please be advised that Hawaiian Electric reserves the right to require additional modifications to any approved design if it is determined during actual construction that additional modifications must be made to address certain field conditions that were not detected or Hawaiian Electric was unaware of during the design review process.



Purpose:

This standard is intended to aid in installing duct seals. Duct seals and plugs are used to prevent the migration of water, gas, and debris through the conduit system.

Criteria:

1. If the ducts are installed below the water table or enter the manhole below the water table, both ends of the duct shall be sealed to prevent water from entering the manhole from split, cracked or leaking joints. (See figure 1)
2. Duct entrances to pad mount transformers and switchgears as well as submersible and walk in vaults shall be sealed. (See figure 2 and figure 3)
3. Both ends of all risers shall be sealed or plugged to prevent water ingress into the duct system. (See figure 4)
4. If the Manholes, Handholes, or Vaults are installed in low lying areas such as gutters or at the bottom of a valley or gulch, then all ducts in the manhole, handhole or vault shall be sealed as well as the upstream structures to prevent the migration of water and debris via the duct system. (See figure 5 and figure 6)
5. Lateral or service ducts that enter a building or structure are required to be sealed by General Order 6 Rule 31.6. The ducline shall be sealed both from last manhole or handhole before the ducts enter the building as well as inside the building to prevent gas and water from entering the building. If a Customer furnishes and installs the service conduit and CABLES, the customer shall be responsible for sealing both ends of the duct run including empty and spare ducts. This is described in the ELECTRIC SERVICE INSTALLATION MANUAL.
6. Other situations that Engineering or Construction and Maintenance deems necessary.

REVISION	DATE	INITIAL
	11-01-02	CT

DRAWN	CT	DESIGNED	RM	APPD	TN	VEC	REDRAWN
SUPERSEDES				CONDUIT AND DUCT SEALING DETAILS			ORIGINAL Dec.1970
ENGINEERING STANDARD HAWAIIAN ELECTRIC CO. INC.				UG DUCTS & STRUCTURES			30-1025
							REV 1
							SHEET 1 of 9

c:\users\ctonokaw\dgn\ug stds\pst301025.0101
ctonokaw
26-JUL-2002 14:05

Standard:

Conduit sealing systems:

1. Duct Seal Compound
 MIMS code 000124040, part number 13155
 - available in 1 or 5 pound blocks
 - prevents moisture and debris from entering system
 - Not intended for watertight or pressure seal.

2. Inflatable Sealing System
 - available for various duct sizes

Conduit Size	MIMS Code Number/Part Number	
	Seal	Clip
2"	000129585/29570	000129668/29578
3"	000129601/29572	000129668/29578
4"	000129627/29574	000129684/29580
5"	000129643/29576	000129700/29582
6"	000129652	000129714

- Requires RDSS-IT inflation tool with CO2 cartridges MIMS code 000129726.
- Should be installed before racking cables and splicing.
- Insulated cable or solder sealed-bare copper neutrals should be used to make a water tight seal.
- Intended for watertight seal or pressure seal.
- Can be used to seal ducts with water flowing up to 16.4 feet of waterhead
- Not typically used to seal empty ducts.

3. Conduit Plugs
 - available for various duct sizes

Conduit Size	MIMS Code Number	Jack Moon Number
2"	000167437	20D236U
3"	000154856	30D346U
4"	000155935	40D402U
5"	000154867	50D402U
6"	000175933	60D637U

- Used to seal empty ducts
- Withstand 30 PSI of water pressure

REVISION
 DATE INITIAL
 11-01-02
 CT -01-074

DRAWN CT	DESIGNED RM	APPD TN	VEC	REDRAWN	
SUPERSEDES				ORIGINAL Dec. 1970	
ENGINEERING STANDARD HAWAIIAN ELECTRIC CO. INC.				30-1025	REV 1
				SHEET 2 of 9	

CONDUIT AND DUCT
SEALING DETAILS
UG DUCTS & STRUCTURES

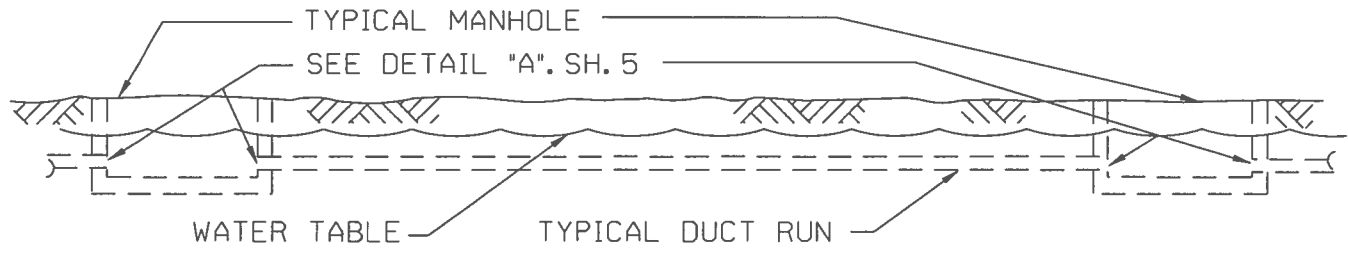

TYPICAL BOX TO BOX RUN
FIGURE 1

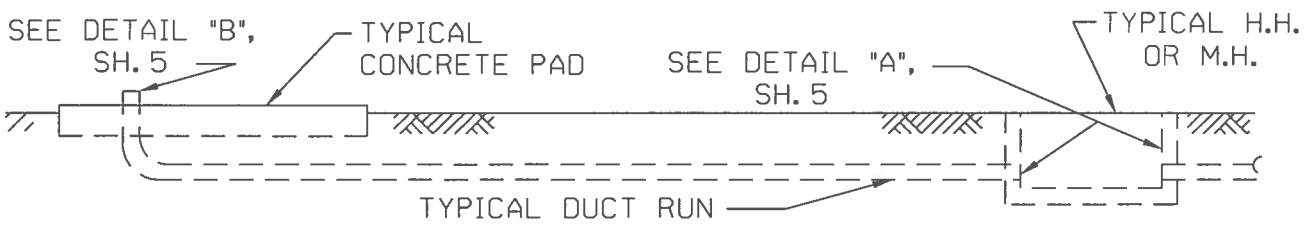

TYPICAL BOX TO PAD RUN
FIGURE 2

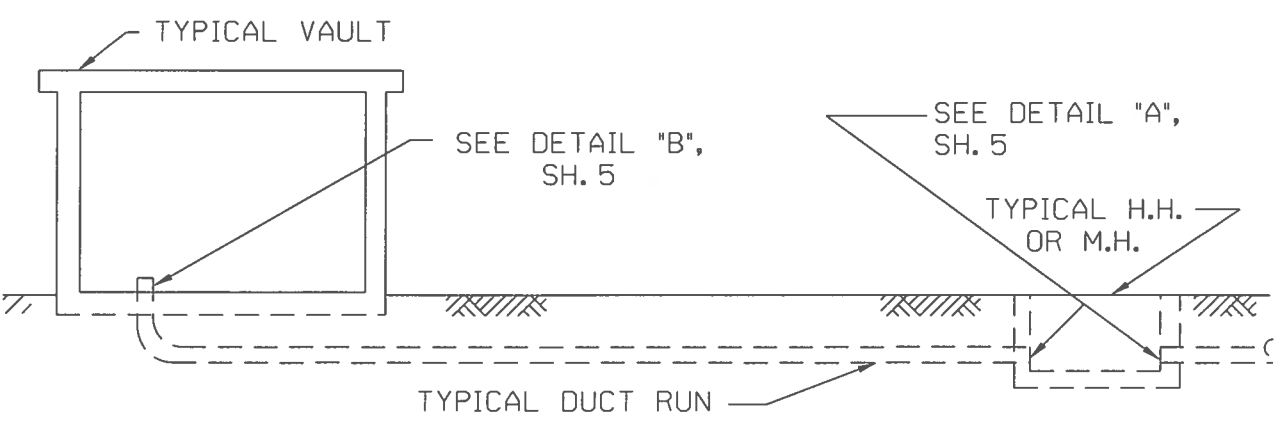

TYPICAL BOX TO VAULT RUN
FIGURE 3

REVISION	DATE	INITIAL
	11-91-02	CT JK

DRAWN	TH II	DESIGNED	RM	APPD	TN	VEC	REDRAWN	
SUPERSEDES							ORIGINAL	DEC. 1970
ENGINEERING STANDARD HAWAIIAN ELECTRIC CO. INC.							30-1025	REV 1
							SHEET	3 of 9

c:\users\ctonokaw\dgn\ug stds\pst301025.0301 ctonokaw 26-JUL-2002 13:55

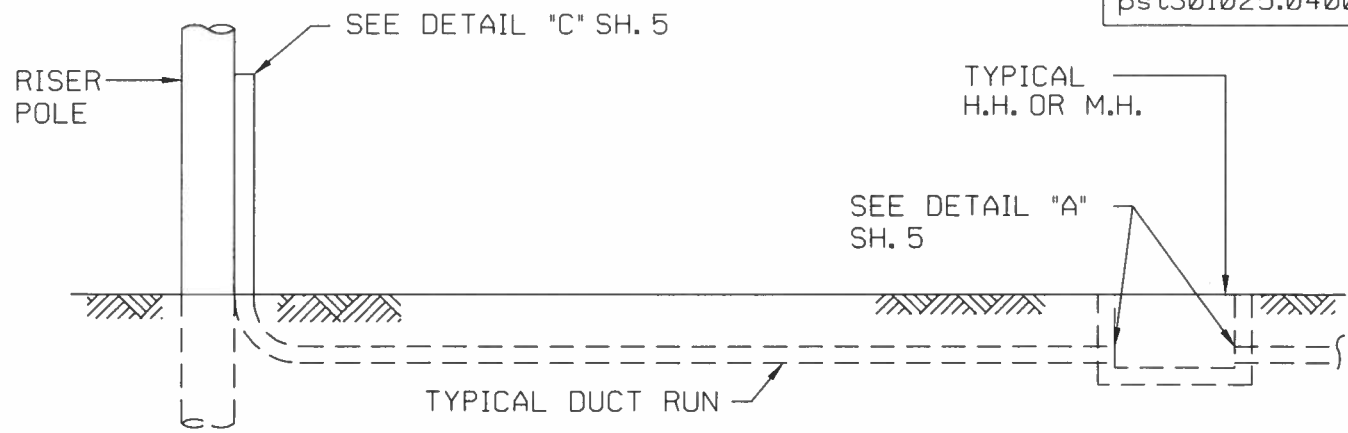

TYPICAL BOX TO RISER RUN

FIGURE 4

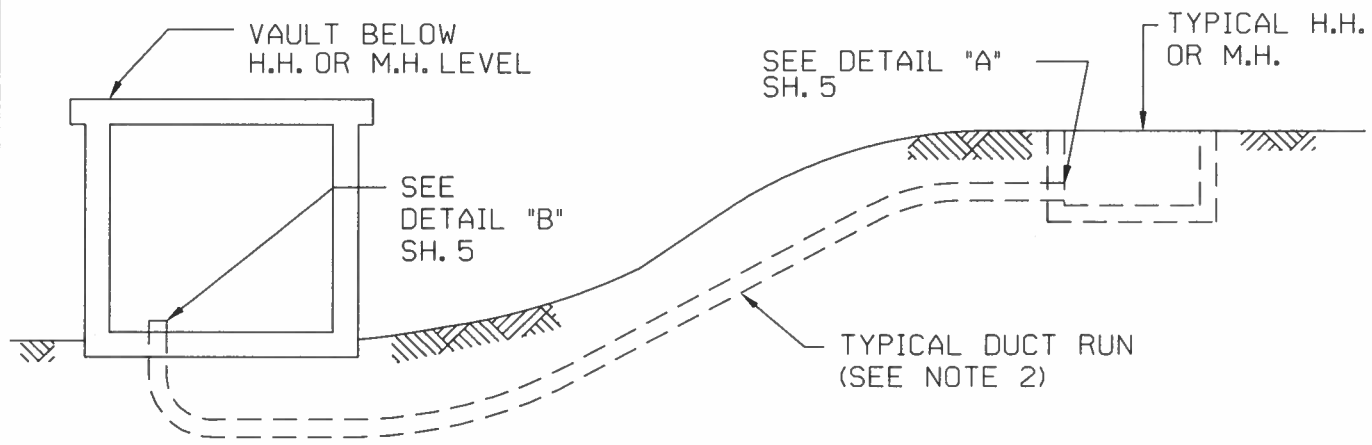

VAULT BELOW THE MANHOLE OR HANHOLE LEVEL

FIGURE 5

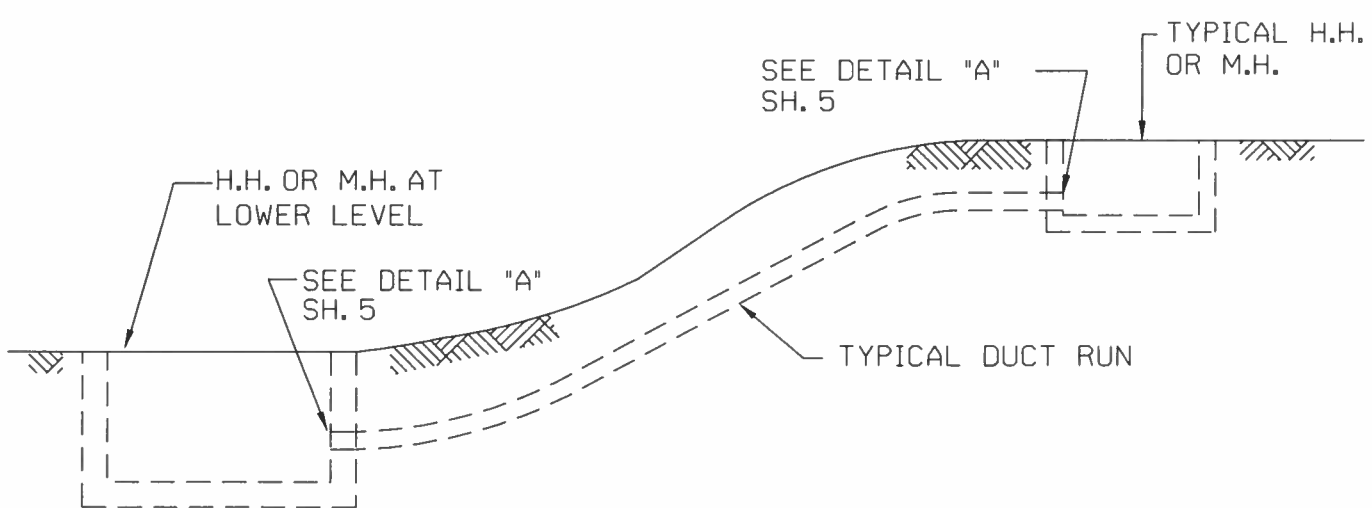

MANHOLE BELOW THE MANHOLE OR HANHOLE LEVEL

FIGURE 6

DATE INITIAL

REVISION

DRAWN TH II DESIGNED DH *dh* APPD *JH*

REDRAWN

ORIGINAL 11-02

30-1025 REV 0

SHEET 4 of 9

ENGINEERING STANDARD
HAWAIIAN ELECTRIC CO. INC.

CONDUIT AND DUCT
SEALING DETAILS
UG DUCTS & STRUCTURES

c:\users\ctonokaw\dgn\ug stds\pst301025.0400

ctonokaw

26-JUL-2002 13:56

APPLY INFLATABLE DUCT SEAL SYSTEM (SEE II-1) OR PACK WITH DUCT SEALING COMPOUND CODE 000124040 (PART NO. 13155)

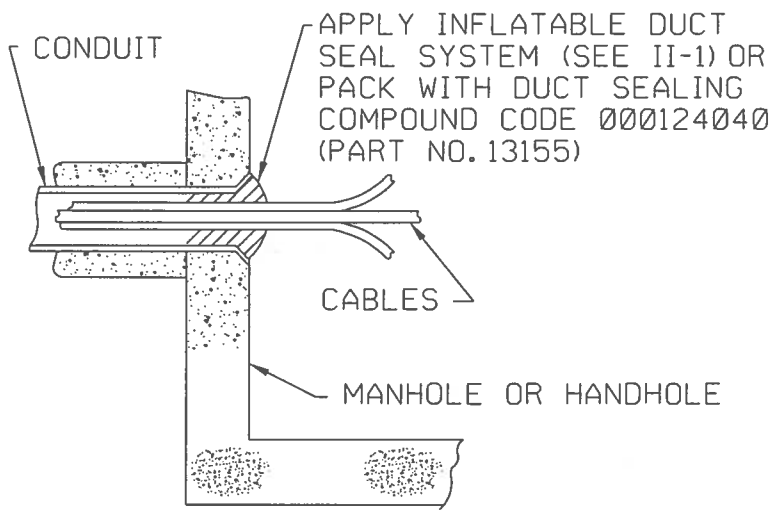

DETAIL "A"

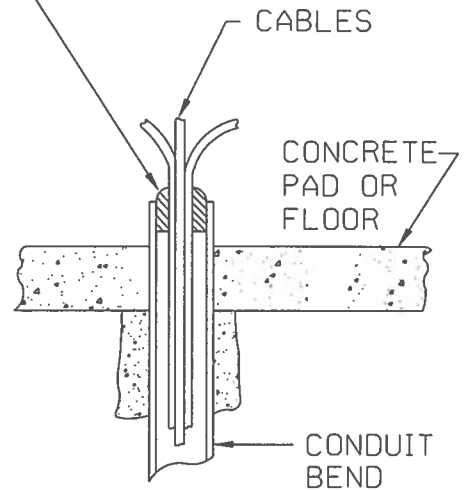

DETAIL "B"

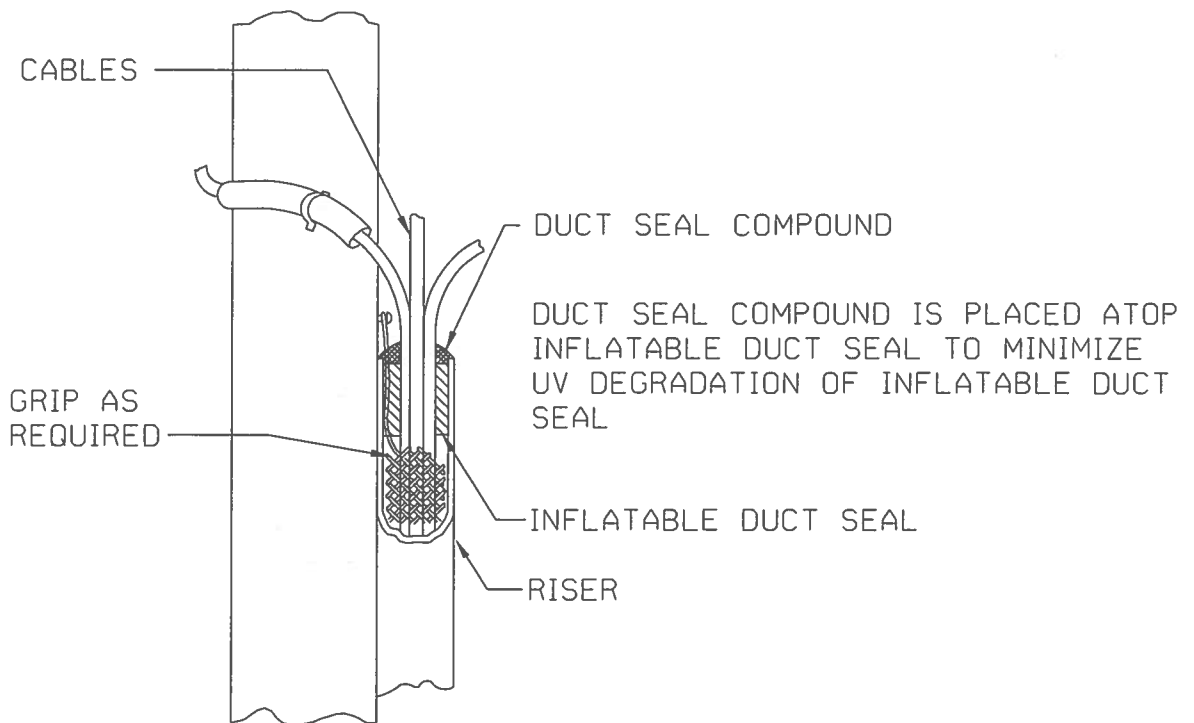

DETAIL "C"

DATE INITIAL

REVISION

DRAWN TH II DESIGNED DH *DA* APPD *JH*

REDRAWN

SUPERSEDES

CONDUIT AND DUCT SEALING DETAILS UG DUCTS & STRUCTURES

ORIGINAL 11-02

ENGINEERING STANDARD HAWAIIAN ELECTRIC CO. INC.

REV 0

SHEET 5 of 9

TOOLING:

RDSS duct seals can be installed with an inflation tool having the capability to inflate RDSS to $43.5 \pm 0.6 \text{ lb/in}^2$ of pressure.

The RDSS-IT-16 inflation tool equipped with a manometer and safety relieve valve using compressed CO2 gas cylinders, HECO MIMS number 000129726.

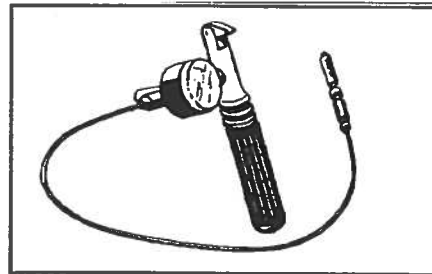

Refer to the operating manual of the specific tool being used.

INSTALLATION:

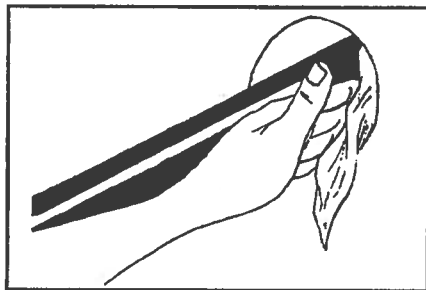

1. It is recommended to wet clean the duct and cable sheath. Remove as much dirt, crust, mud, etc. as possible.

For ducts with 3 or more cables, continue with step 2.
For 0, 1, or 2 cables, skip to step 9.

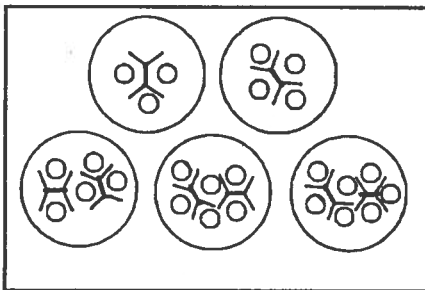

2. Examples for different multiple cable configuration. One RDSS-Clip can seal up to four cables. If more cables are to be sealed, use one extra clip per three additional cables. It is recommended that duct seals are installed before cable splices are made.

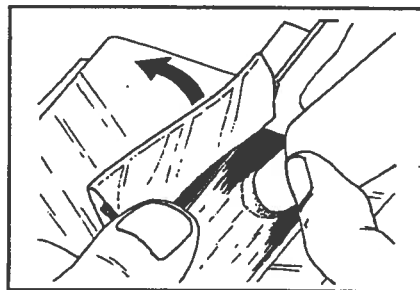

3. Open clip wings on one side. Lubricate the wings abundantly to ensure that they don't stick together.

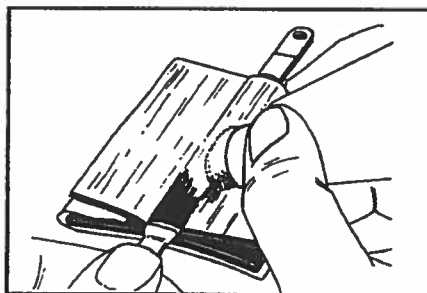

4. Remove one protection paper and lubricate abundantly the larger surface of the clip wing.

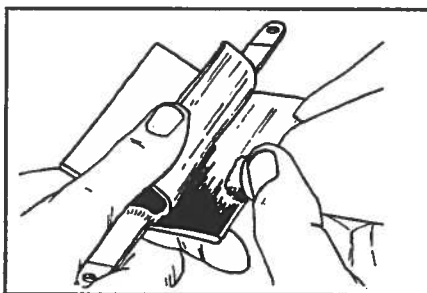

5. Repeat steps 3 & 4 for the other clip wings. Remove protection paper only after lubricating at least one wing side.

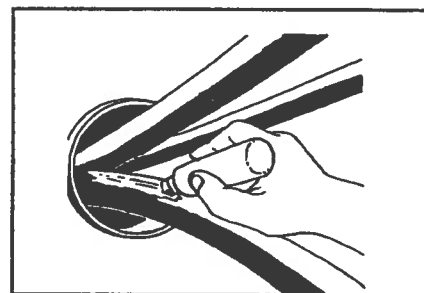

6. Abundantly lubricate the cables in the crotch area as much as possible.

DATE
INITIAL

REVISION

DRAWN CT DESIGNED DH APPD

[Handwritten signature]

REDRAWN

ORIGINAL 11-02

30-1025 REV 0

SHEET 6 of 9

SUPERSEDES

ENGINEERING STANDARD
HAWAIIAN ELECTRIC CO. INC.

CONDUIT AND DUCT
SEALING DETAILS
UG DUCTS & STRUCTURES

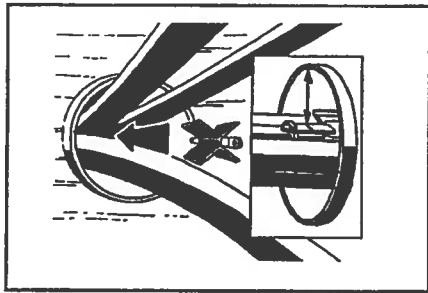

7. Insert the clip between the cables, assuring that there is only one cable between each clip wing (see picture, step 2).

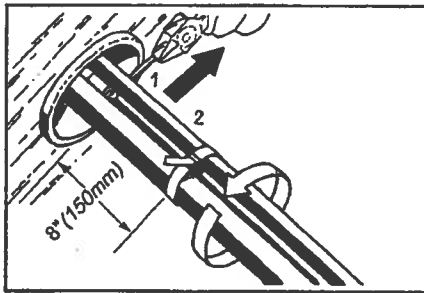

8. Install the long tie-wrap around the cable bundle at a distance of approx. 8" (150mm) from the duct entrance.

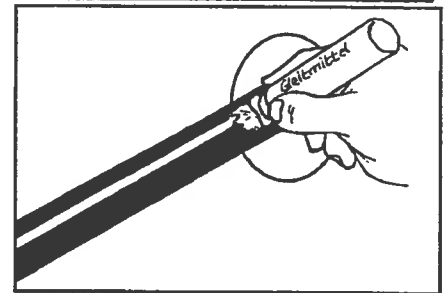

9. For ease of installation lubricate the cable sheaths.

Make sure that the central part of the clip is well positioned in the crotch area. The raised line on the center stick should be flush with the end of the duct. Use the short tie-wrap to hold the clip in place. Cut off the excess tie-wrap and position the locking part between the cables.

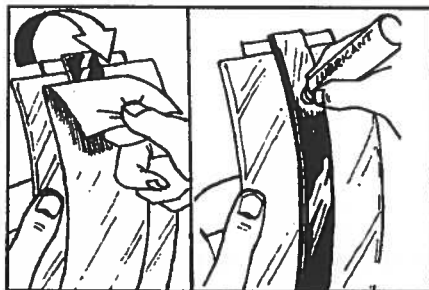

10. Remove the protective paper from the outside of the sealing strip and lubricate abundantly.

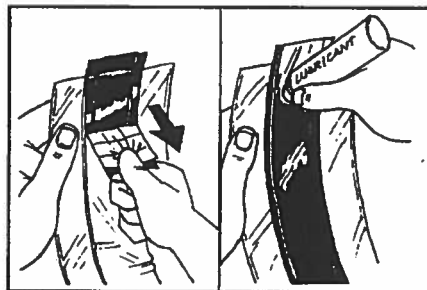

11. Continue with lubrication of the inside of the sealing strip.

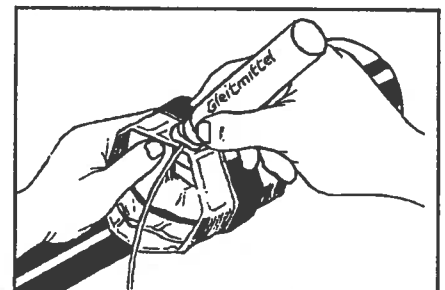

12. Lubricate the filling tube on the RDSS section.

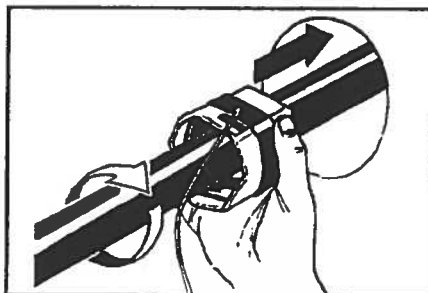

13. Wrap RDSS around the cable (or cable bundle) and slide completely into the duct.

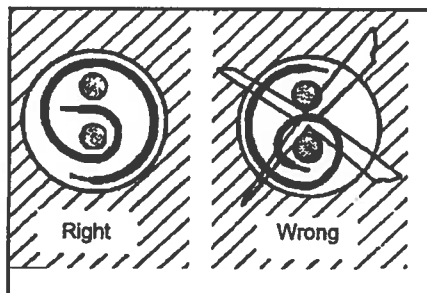

14. In case of two cables, wrap RDSS around the cables as shown starting with the largest cable.

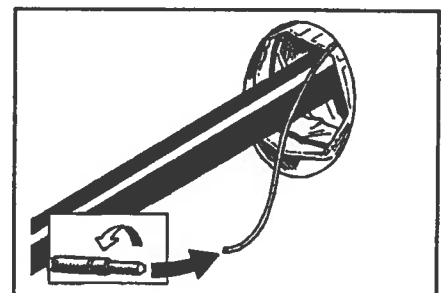

15. Connect the filling tube to the tube snap of the inflation tool. Gently insert the filling tube until it will not go any further. Tighten down the nozzle.

DATE INITIAL

REVISION

DRAWN CT DESIGNED DH APPD *JH*

SUPERSEDES

REDRAWN

ORIGINAL 11-02

30-1025 REV 0

SHEET 7 of 9

ENGINEERING STANDARD HAWAIIAN ELECTRIC CO. INC.

CONDUIT AND DUCT SEALING DETAILS UG DUCTS & STRUCTURES

c:\users\ctonokaw\dgn\ug stds\pst301025.0700

ctonokaw

26-JUL-2002 13:57

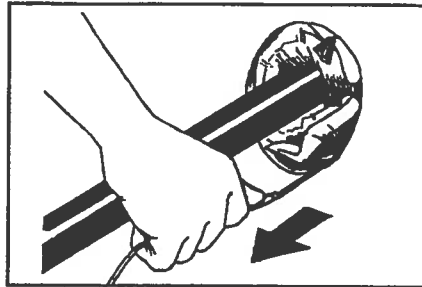
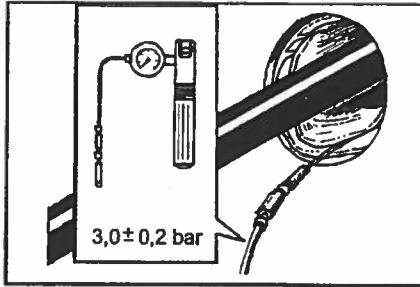

16. Inflate RDSS up to the pressure of 3.0 bar (43.5 psi) and keep the pressure there for 30 seconds, after which the tool must be shut off.

17. BEFORE removing the installation tool connection from the filling tube, pull out the filling tube in one gentle move in the direction of the cable.

NOTE: Please refer to the operation manual for the specific inflation tool being used.

REMOVAL:

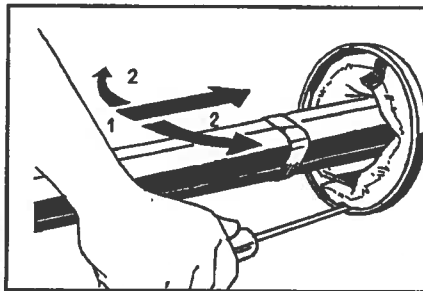

1. Deflate the RDSS duct seal by piercing with a screw driver. Release the RDSS from duct wall by using blunt tool.

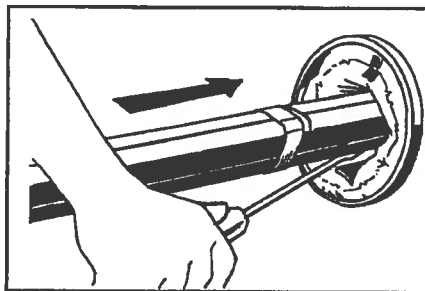

2. Release RDSS from the cable or cable bundle.

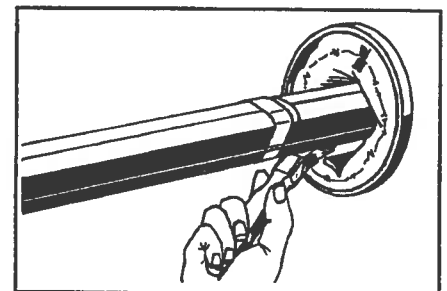

3. Apply lubricant on the released areas.

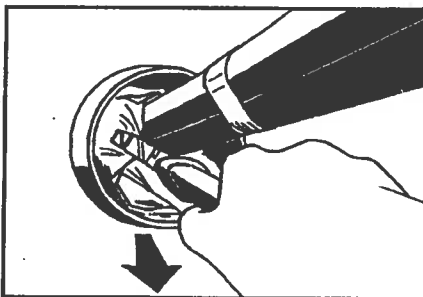

4. Remove RDSS out of the duct with a pair of pliers.

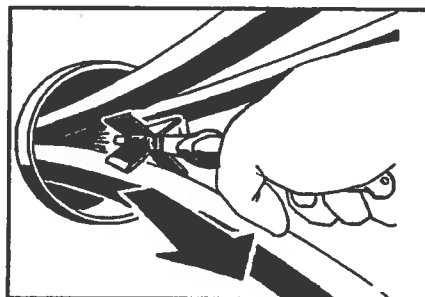

5. If applicable: Remove tie-wraps from the cable bundle. Spread cables. Remove clip core and sealant as much as possible with a pair of pliers.

DATE INITIAL

REVISION

DRAWN CT DESIGNED DH APPD *JH*

REDRAWN

SUPERSEDES
ENGINEERING STANDARD
HAWAIIAN ELECTRIC CO. INC.

CONDUIT AND DUCT
SEALING DETAILS
UG DUCTS AND STRUCTURES

ORIGINAL 11-02
30-1025 REV 0
SHEET 8 of 9

c:\users\ctonokaw\dgn\ug stds\pst301025.0800

ctonokaw

26-JUL-2002 13:58

BLANK DUCT PLUGS
INSTALLATION INSTRUCTIONS

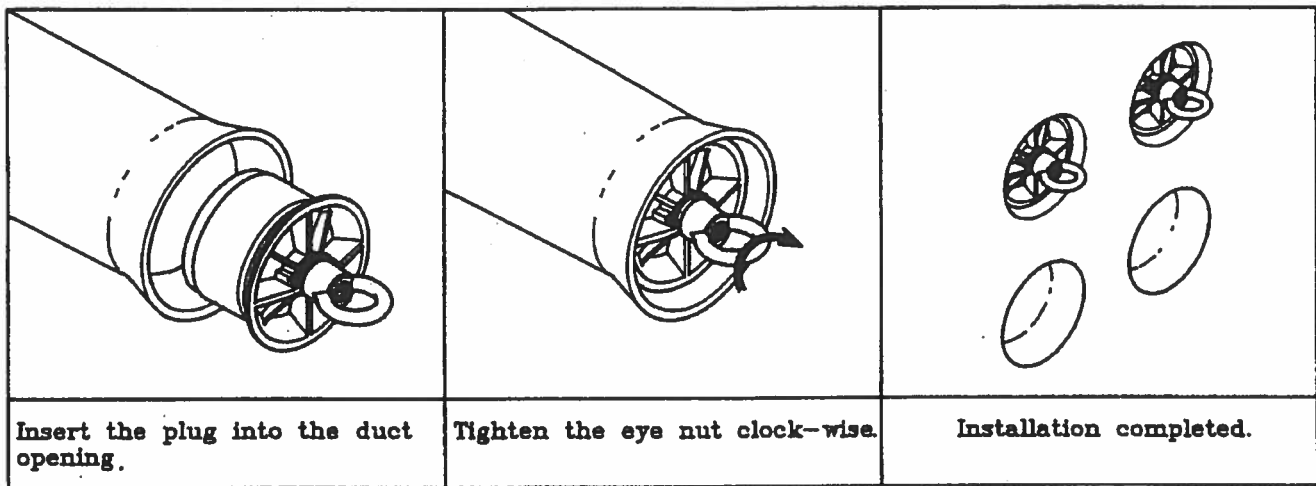
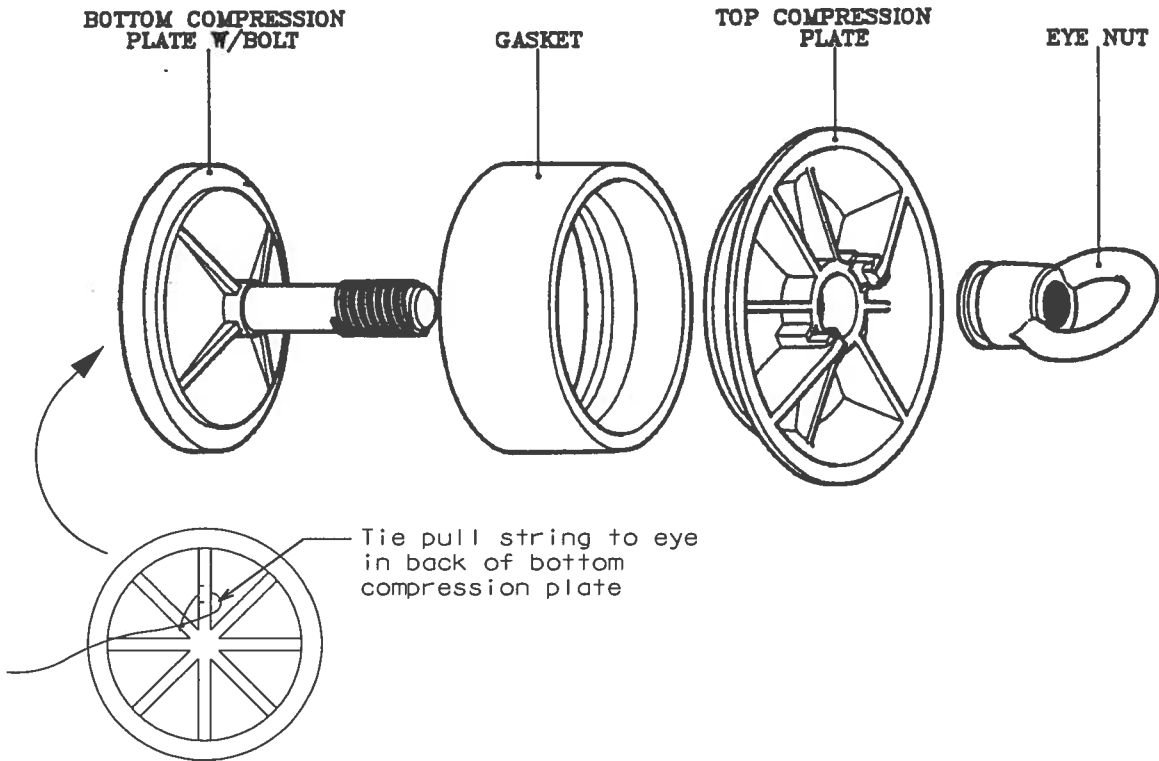

DATE
INITIAL

REVISION

DRAWN CT DESIGNED DH APPD

J. W. armit

REDRAWN

ORIGINAL 11-02

30-1025 REV 0

SHEET 9 of 9

SUPERSEDES
ENGINEERING STANDARD
HAWAIIAN ELECTRIC CO. INC.

CONDUIT AND DUCT
SEALING DETAILS
UG DUCTS & STRUCTURES